



RUBINETTERIE

F.lli Frattini®

Made in Italy dal 1958

ISTRUZIONI DI INSTALLAZIONE INCASSO DOCCIA UNIVERSALE 98011

BUILT-IN SHOWER MIXERS INSTALLATION INSTRUCTIONS

INSTRUCTIONS DE MONTAGE MITIGEURS DE DOUCHE A ENCASTRER

INSTRUCCIONES DE MONTAJE MEZCLADOR A ENCAJE PARA DUCHA

INSTALLATIONSANWEISUNGEN DER DUSCHE MIT AUTOMATISCHEM UMSTELLER

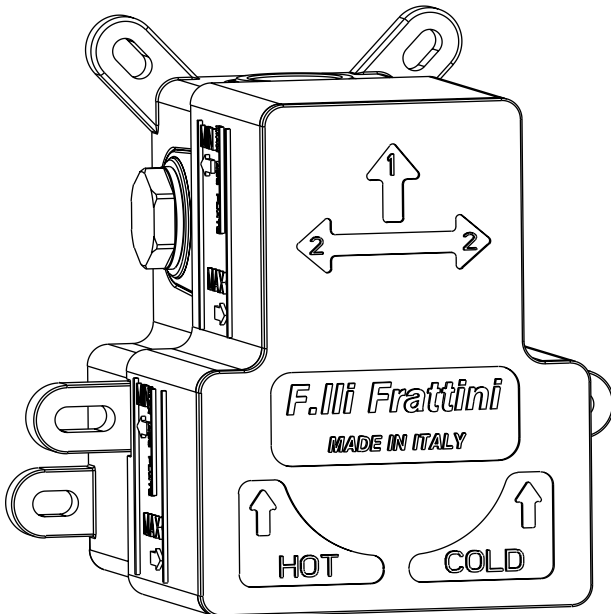

VIDEO ISTRUZIONI
DI INSTALLAZIONE



INDICE
Index
Sommaire
Indice
Inhaltsverzeichnis

■ SPECIFICHE TECNICHE DI FUNZIONAMENTO Technical specifications Donnes techniques de fonctionnement Especificaciones técnicas de funcionamiento Technische daten	pag.1
■ ATTENZIONE! SPURGARE LE TUBAZIONI Pipes cleaning Purge de la tuyauterie Limpieza tuberías Rohre Säuberung	pag.2
■ DIMENSIONALE Dimensional drawing Dessin des encombrements Diseño dimensional Masszeichnung	pag.3
■ UNIVERSAL BOX	pag.4
■ SCHEMA TECNICO DI ENTRATE E USCITE PROVA-IMPIANTO Inlet-outlet technical scheme – Leakproofness test Schéma technique entrés, sorties – Test d'étanchéité Esquema técnico de la entrada y de la salida – Test hermeticidad de la instalacion Auslauf und Zulauf technisches Zeichnung – Dichtigkeit Prüfung	pag.5
■ INSTALLAZIONE Installation Installation Montaje Einbau	pag.6-7
■ RACCOMANDAZIONE PER LA PULIZIA DEI PRODOTTI Cleaning Nettoyage Limpieza Reinigung	pag.8
■ DATI DI PORTATA Flow rate Debit de l'eau Datos de portada Durchflussmenge Daten	pag.9

SPECIFICHE TECNICHE DI FUNZIONAMENTO

Technical specifications

Donnes techniques de fonctionnement

Especificaciones técnicas de funcionamiento

Technische daten

IT Dati tecnici, consigli di manutenzione e pulizia.

- Pressione minima:
0.05 MPa (0.5 bar)
- Pressione massima:
1.00 MPa (10 bar)

Tuttavia per avere la massima resa in termini di durata e manovrabilità è consigliabile che la pressione abbia i seguenti valori:

- Pressione minima:
0.1 MPa (1 bar)
- Pressione massima:
0.5 MPa (5 bar)

In caso la pressione superi i 0,6 Mpa si consiglia di installare un **riduttore di pressione**. Sono inoltre da evitare forti differenze della stessa tra l'alimentazione dell'acqua calda e fredda. Prima di procedere all'installazione del rubinetto è necessario pulire le tubature per eliminare eventuali detriti inoltre è consigliabile, a monte della rubinetteria, installare dei rubinetti d'arresto con filtro. I nostri prodotti non necessitano di manutenzione, fatta eccezione della pulizia periodica dell'aeratore.

EN Technical details, maintenance and clean advices

- Minimal pressures:
0.05 MPa (0.5 bar)
- Maximum pressures:
1.00 MPa (10 bar)

The way to obtain the maximal performance in duration and **manoeuvrability** it is suggested that the pressure of the water stay as following:

- Minimal pressures:
0.1 MPa (1 bar)
- Maximum pressures:
0.5 MPa (5 bar)

In case that the pressure exceeds 0,6 Mpa it is suggested to install a

pressure reducer, and strong pressure differences between the inlet of the warm and cold water have to be avoid. Before proceeding the installation of the mixer it is necessary to clean the piping in way to eliminated eventual silts, moreover it is suggested to install stop cocks with filter. Our products do not require service or maintenance, with the exception of the periodical cleaning of the aerator.

FR Données techniques, conseils d'entretien et de nettoyage.

- Pression minimale:
0,05 MPa (0,5 bar)
- Pression maximale:
1,00 MPa (10 bar)

Cependant, pour des performances maximales en termes de durabilité et de maniabilité, il est recommandé que la pression ait les valeurs suivantes:

- Pression minimale:
0,1 MPa (1 bar)
- Pression maximale:
0,5 MPa (5 bars)

Si la pression dépasse 0,6 MPa, il est conseillé d'installer un **réducteur de pression**. Il faut également éviter les fortes différences entre l'alimentation en eau chaude et froide. Avant de procéder à l'installation du robinet, il est nécessaire de nettoyer les tuyaux pour éliminer tout débris. Il est également conseillé d'installer des robinets d'arrêt avec un filtre en amont des robinets. Nos produits ne nécessitent aucun entretien, sauf pour le nettoyage périodique de l'aérateur.

SP Datos técnicos, consejos de mantenimiento y limpieza.

- Presión mínima:
0.05 MPa (0.5 bar)
- Presión máxima:
1.00 MPa (10 bar)

Sin embargo, para obtener el máximo

rendimiento en términos de durabilidad y maniobrabilidad, se recomienda que la presión tenga los siguientes valores:

- Presión mínima:
0.1 MPa (1 bar)
- Presión máxima:
0.5 MPa (5 bar)

Si la presión supera los 0,6 Mpa, se recomienda instalar un **reductor de presión**. También deben evitarse las fuertes diferencias entre el suministro de agua caliente y fría. Antes de continuar con la instalación del grifo, es necesario limpiar las tuberías para eliminar los residuos. También se recomienda instalar llaves de paso con un filtro aguas arriba de los grifos. Nuestros productos no requieren mantenimiento, excepto la limpieza periódica del aireador.

DE Technische Daten, Empfehlungen zur Instandhaltung und Reinigung

- Mindestdruck:
0.05 MPa (0.5 bar)
- Höchstdruck:
1.00 MPa (10 bar)

Der Druck sollte sich innerhalb folgender Werte befinden, damit ein Höchstmaß an Lebensdauer und Handlichkeit gewährleistet ist:

- Mindestdruck:
0.1 MPa (1 bar)
- Höchstdruck:
0.5 MPa (5 bar)

Sollte der Druck 0,6 MPa (6 bar) übersteigen, ist der Einbau eines **Druckminderventils** angebracht. Darüber hinaus sind bei der Warm und Kaltwasserversorgung starke Druckunterschiede zu reinigen, um eventuelle Schmutzablagerungen zu entfernen. Es ist außerdem empfehlenswert, vor der Armatur Absperrventile mit Filter einzubauen. Unsere Produkte sind mit Ausnahme des Luftsprudlers wartungsfrei.

ATTENZIONE

Spurgare le tubazioni prima di collegare il rubinetto all'impianto, per garantire un buon funzionamento

Clean carefully the pipes before connecting the tap to the system to ensure a good operation

Purger les tuyauteries avant de brancher le robinet à l'installation, pour garantir un bon fonctionnement

Limpiar la tuberías antes de conectar el grifo en el sistema, para asegurar un buen funcionamiento

Vor der Installation der Armatur sind alle Rohrleitungen gut durchzuspülen, um eine gute Funktion zu gewährleisten

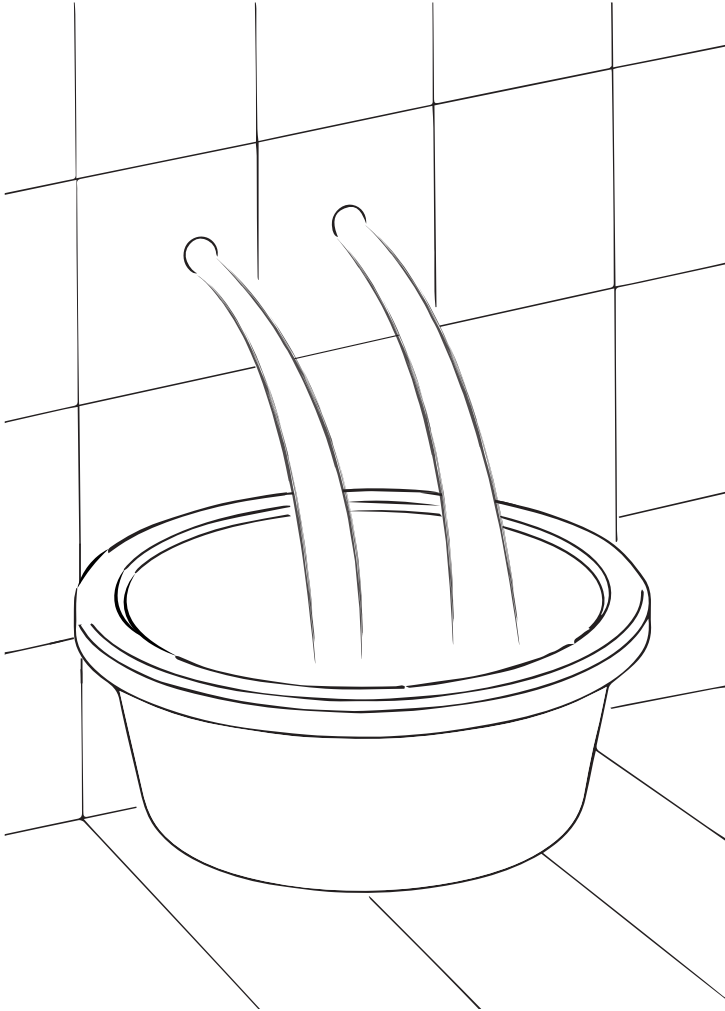

DIMENSIONALE

Dimensional drawing
Dessin des encombrements
Diseño dimensional
Maszeichnung

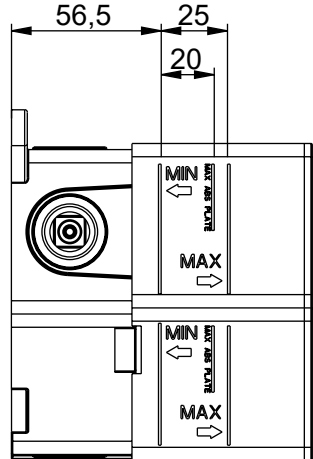
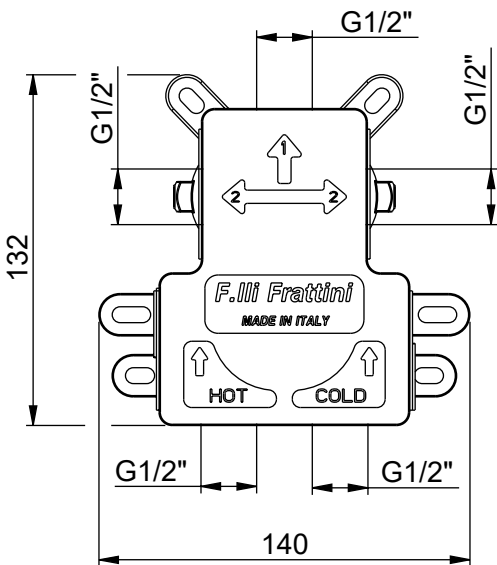
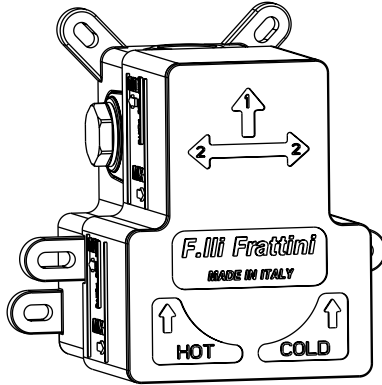

UNIVERSAL BOX

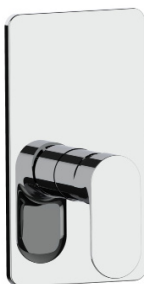
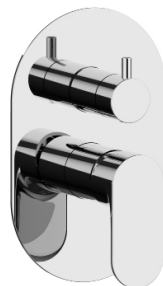

SCHEMA TECNICO DI ENTRATE E USCITE - PROVA IMPIANTO

Inlet-outlet technical scheme – Leakproofness test

Schéma technique entrés, sorties – Test d'étanchéité

Esquema tecnico de la entrada y de la salida – Test hermeticidad de la instalacion

Auslauf und Zulauf technisches Zeichnung – Druckprobe

CONFIGURAZIONE 1 VIA - 1 WAY - 1 VOIE - 1 VIA - 1 WEG

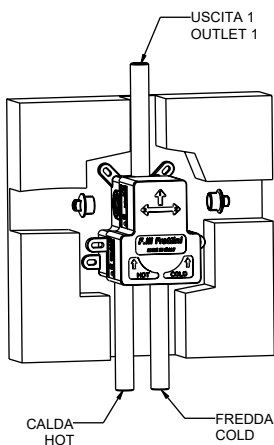

CONFIGURAZIONE 2 VIE CON DEVIATORE - 2 WAY - 2 VOIES - 2 VIAS - 2 WEGE

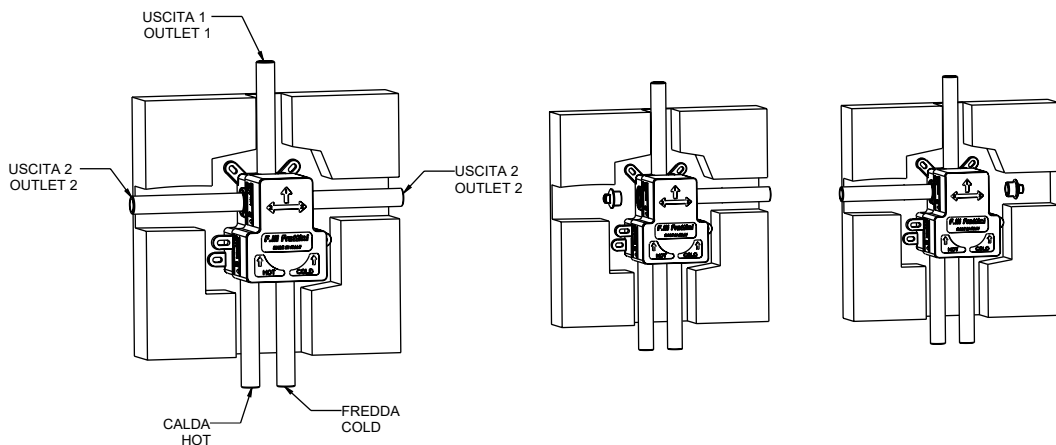

INSTALLAZIONE

Installation
Installation
Montaje
Einbau

1

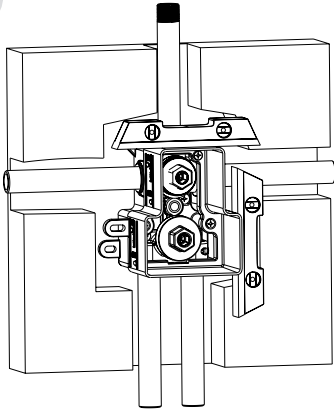

2

Test impianto - Leaking test - Test etancheité -
Prueba de la instalación Druckprobe

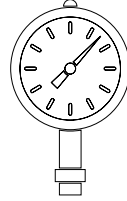
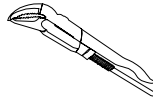

3

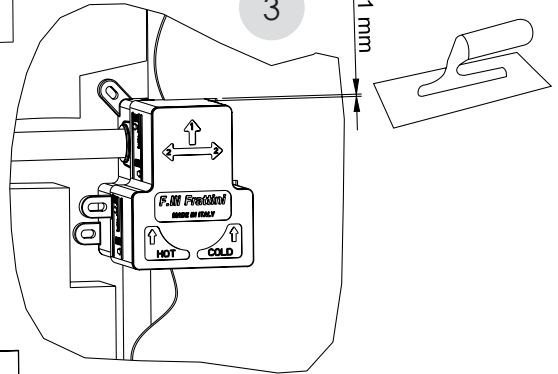

4

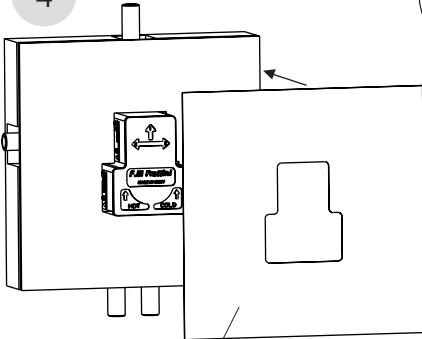

ATTENZIONE!

Guarnizione isolante

- Insulating gasket - Manchette
d'isolation - Guarnición aislante -
Dichtmanschette

5

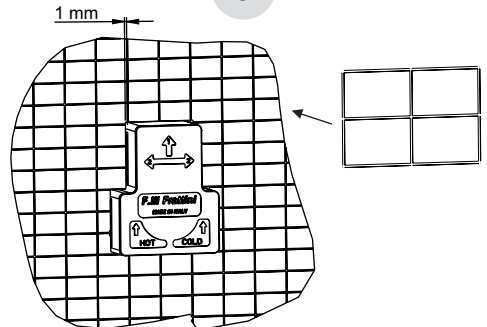

INSTALLAZIONE

Installation
Installation
Montaje
Einbau

6

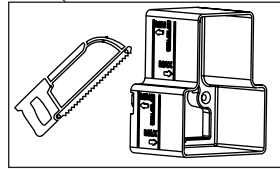
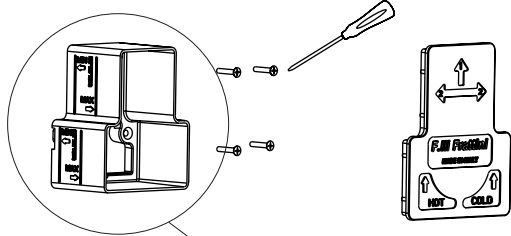
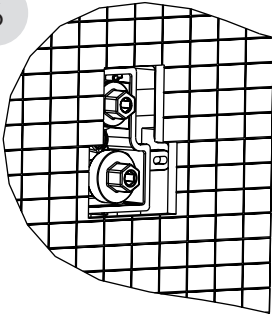

7

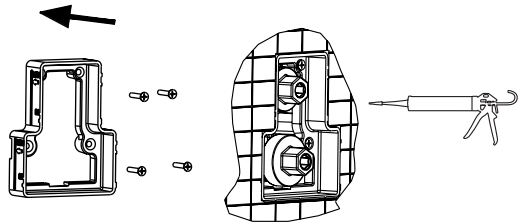
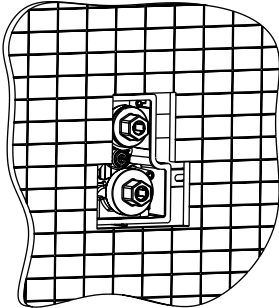

ATTENZIONE!

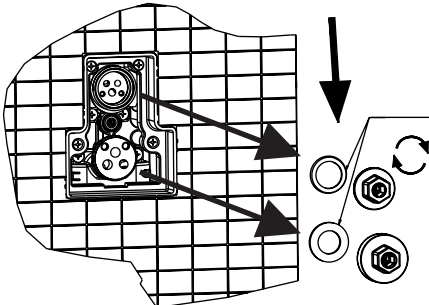

N.B.
PRIMA DI INSTALLARE LE CARTUCCE
ASSICURARSI DI TOGLIERE
LE GUARNIZIONI DAL CORPO

Remove the gaskets from
the built-in mixer body

RACCOMANDAZIONE PER LA PULIZIA DEI PRODOTTI

Cleaning
Nettoyage
Limpeza
Reinigung

IT Per una pulizia regolare, usare un panno morbido, sapone e acqua. Asciugare con uno straccio asciutto. Evitare di usare detergenti o solventi che potrebbero danneggiare la superficie. I danni dovuti a un trattamento non conforme effettuato dall'utente non sono coperti dalla nostra garanzia.

EN Use soft cloth, soapy solution and water for regular care. Wipe with a dry cloth. Avoid the use of abrasives or solvents, which damage the surface. Damage caused by inappropriate treatment by the user, is not covered by our guarantee.

FR Pour un entretien régulier, utiliser un chiffon doux, du savon et de l'eau. Essuyer avec un chiffon sec. Évitez d'utiliser des détergents ou des solvants qui endommageraient cette surface. Les dommages résultant d'un traitement non conforme effectué par l'utilisateur sont exclus de la garantie que nous offrons.

ES Para un mantenimiento periódico usar un paño blando, jabón y agua. Secar con un pano seco. Evitar el uso de productos abrasivos o disolventes que dañen la superficie. Los daños causados por un manejo inadecuado del usuario no los cubre nuestra garantía.

DE Zur regelmäßigen Pflege weiches Tuch, Seifenlauge und Wasser verwenden. Mit trockenem Tuch abtrocknen. Vermeiden Sie den Einsatz von Scheuermitteln oder Lösungsmitteln, die die Oberfläche beschädigen. Schäden, die durch unsachgemäße Behandlung durch den Benutzer entstehen, entziehen sich unserer Garantieleistung



DATI DI PORTATA

Flow rate

Debit de l'eau

Datos de portata

Durchflussmenge Daten

ART. XX011 - INCASSO 2 VIE C/CART. DEV. USCITA LATERALE SCARICO LIBERO

ART. XX011 - 2 way built-in with diverter side exit - free outlet

ART. XX011 - Corps encastrée 2 voies - sortie latérale

ART. XX011 - Mezclador eEncaje 2 vías - salida lateral

ART. XX011 - UP-Mischer 2 Wege - Seiten Auslauf

PRESSIONE - Bar PRESSURE - Bar	PORTATA L/Min - MISCELATA FLOW RATE (L/MIN) - MIXED 38°C
0,5	5,1
1	7,2
1,5	8,8
2	10
2,5	11,2
3	12,1
4	14
5	15,7

ART. XX011 - INCASSO 2 VIE C/CART. DEV. USCITA FRONTALE SCARICO LIBERO

ART. XX011 - 2 way built-in with diverter frontal exit - free outlet

ART. XX011 - Corps encastrée 2 voies - sortie frontale

ART. XX011 - Mezclador eEncaje 2 vías - salida frontal

ART. XX011 - UP-Mischer 2 Wege - Vordere Auslauf

PRESSIONE - Bar PRESSURE - Bar	PORTATA L/Min - MISCELATA FLOW RATE (L/MIN) - MIXED 38°C
0,5	5,8
1	7,8
1,5	9,6
2	11,1
2,5	12,4
3	13,5
4	15,5
5	17,3



RUBINETTERIE

F.lli Frattini[®]

Produttori di rubinetteria
Made in Italy da oltre 60 anni

Via Roma, 125 - 28017 San Maurizio d'Opaglio (NO) ITALY

tel. 0322 96127 - fax 0322 967272

www.frattini.it - info@frattini.it

